

LINEAR TASK/GENERAL LIGHTING INSTALLATION GUIDE

Precautions



Risk of electrical shock. Disconnect power before servicing or installing product.

Risque de choc électrique. Coupez l'alimentation avant l'entretien ou l'installation du produit.



Risk of injury. Wear safety glasses and gloves during installation and servicing.

Risque de blessure. Porter des lunettes de sécurité et des gants lors de l'installation et de l'entretien.



Risk of injury or damage. Unit will fall if not installed properly. Follow installation instructions.

Risque de blessures ou de dommages. Unité va tomber s'il n'est pas installé correctement. Suivez les instructions d'installation.



Risk of injury or damage. LED light sources achieve full intensity immediately after powered. Do not look directly into lights.

Risque de blessures ou de dommages. Sources de lumière LED parvenir à pleine intensité immédiatement après sous tension. Ne regardez pas directement la lumière.

Introduction

The Linear Task Series of fixtures provide an ample amount of illumination for most general task lighting needs. Available in advanced White LED, providing years of service while significantly reducing energy usage. This fixture can accept any reflector from our Linear line, allowing a multitude of light patterns for use in general and task lighting applications.

This luminaire is designed to be used in ambient temperatures of -20C to +40C (-4F to +104F) and be mounted horizontally with the light source down. This luminaire is rated for damp locations. It should not be mounted in wet locations in which water can flow into the luminaire.

Getting Started

UNBOXING

Our packaging is designed to protect the luminaire during shipping. Please inspect to confirm it was not damaged during the process.

HANDLING

Once unpacked, the luminaire can become damaged if mishandled. Do not stack luminaires after unpacking.

PACKAGE CONTENTS

- Light fixture - (assembled)
- Installation Instructions
- Gripple hangers
- Junction box lid with screw



Installation

It is recommended to first mount the fixture in the desired position before wiring or installing optional reflectors.

MOUNTING

The Linear series task lights can be mounted using a variety of hardware, such as cable, hook, or chain. The following steps utilize the recommended ETG-YSM-05 Mounting Cables.

- 1) Install cable to the desired fixture height using proper hardware based on application (follow local code if necessary).
- 2) Loop cable around mounting point or hardware and slide through locking mechanism.
- 3) Locate Mounting Holes in bracket

mounting continued on next page...

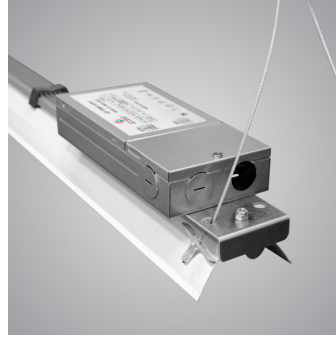
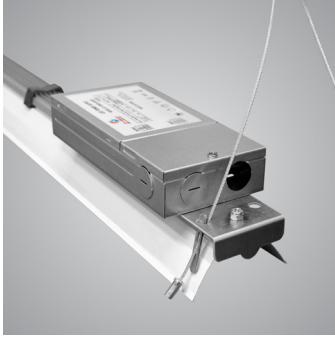

- 4) Loop hooks from the mounted cable through the set of holes on each end of the fixture: 4 hooks total.
- 5) Using a leveling tool, adjust the cable length at the locking mechanism to level the fixture horizontally.

Wiring

Make all electrical connections in accordance with the National Electrical Code and local code requirements. Verify that supply voltage is correct by comparing it to the product label. The wire lead from the luminaire power supply should be connected to the service wiring.

The standard power supply will have the following connections:

WIRE COLOR	FUNCTION
Green/Yellow	Ground
Brown or Black	A/C Line
Blue or White	A/C Neutral

1

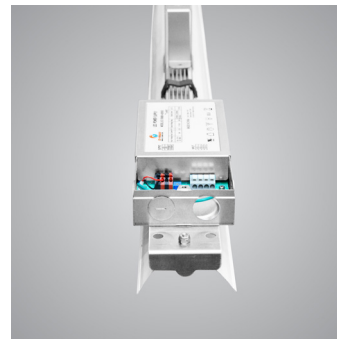

- Ensure the circuit is not receiving power prior to wiring the unit
- Remove the desired gland hole and use the desired gland per local codes
- Ensure that the gland provides sufficient strain relief to prevent damage to the unit

2

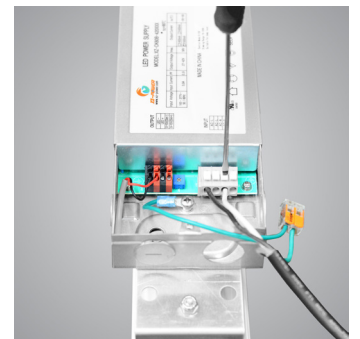
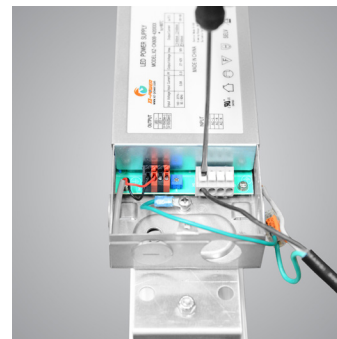
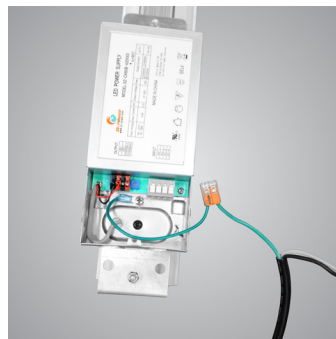
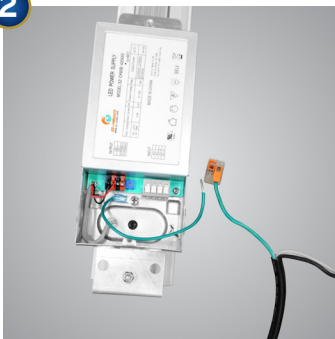

- Connect the incoming ground with the junction box grounding wire (Terminal not included)
- Insert the line into the terminal labeled AC-L
- Insert the neutral wire into the terminal labeled AC-N

3



Connect the dimming wire to the terminals marked “0-10V (Dim-)” and “0-10V (Dim+)” if used.

Cleaning

To maintain efficiency, the LED lens **should be cleaned with a mild soap or neutral PH cleaner**. Abrasives or cleaners containing chlorinated or aromatic hydrocarbons should not be used. Once clean, rinse with water and wipe dry using a soft cloth.

Technical Support

Tel: 317 916-4274 **Web:** <http://www.hornerlighting.com> **Email:** techspt@hornerlighting.com